

# Installation Sheet | Magnetic Surface Short Track ( 2085 )

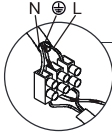
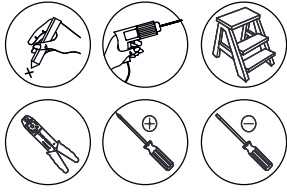

### How to Connecting the Terminal Block

Connect main supply (brown - Live, blue - Neutral) into terminal block making sure all connections are tight.

Please read instructions before commencing installation and retain for future reference.

### INSTALLATION INSTRUCTIONS

**⚠** Electrical products can cause death, injury, or damage to property. Maintenance and installation should only be carried out by a professional electrician.

- Make sure the power stay on power OFF position before safe operation.
- Check the lighting fixture and accessories before installation.
- If there is any damage in lamp body or glass, please stop the installation.
- Make sure that the products is installed properly before connecting to electricity.
- Do not cover the fitting.
- Not for outdoor use or in wet conditions.

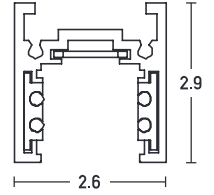

**step 1.:** The magnetic profile has pre-drilled holes in the top. Touch it on the mounting surface and mark these points.

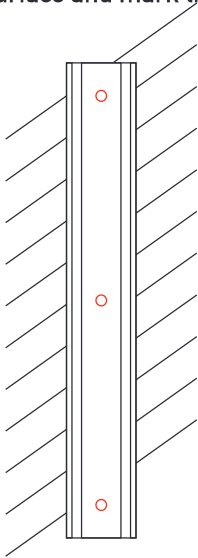

**step 2.:** Drill the points and insert dowels into mounting surface. Touch profile on the mounting surface and align the holes.

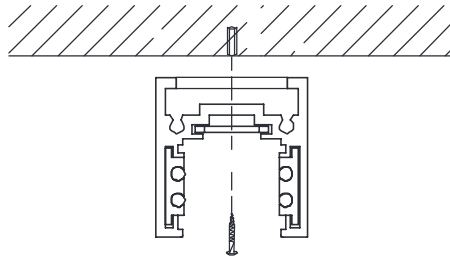

**step 3.:** Fit magnetic profile onto mounting surface with self-tapping screws.

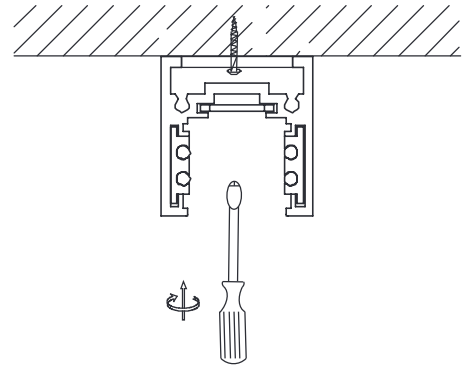

**step 4.:** Put the end caps to the profile and secure with the screws.

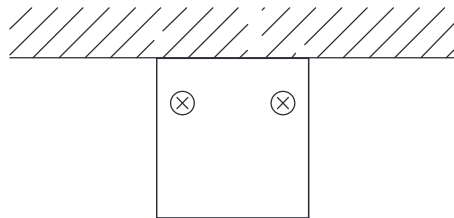

Plastic End Cap.:  
Color Black / Code 20101-B  
Color White / Code 20101-W

**step 5.:** Connect the feeder and insert the magnetic luminaire.

