

Wireless PIR Sensor

Installation Instructions

Clear Pairing:

Long press the pairing button on the controller for 10-15 seconds (depending on the model), until the red indicator light goes out.
The pairing with the PIR sensor will be cleared.



PIR Sensor Setting:

Remove the silicone cover and use the knobs on the top of the PIR sensor to adjust the lux level, the sensitivity and the delay time.
Turn the knobs clockwise to increase the value, or counter-clockwise to decrease the value.

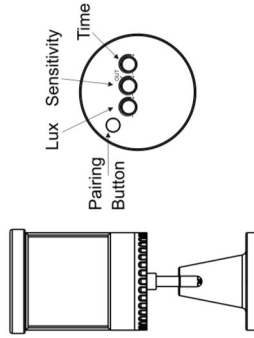

Specifications

Wireless PIR Sensor Technical Parameters:

- Switch Type:** PIR Sensor
- Power Supply:** 1 x CR2450 Battery (included)
- Battery Life:** Up to 2 years
- Communicating Frequency:** RF 433Mhz
- Control Distance:** up to 20m
- Control Method:** Pairing with Controllers
- IP Rating:** IP65 (using included Silicone Cover)
- Sensitivity Range:** up to 10m indoor / 7m outdoor
- Lux Level:** 30-3500lux
- Time Range:** 3sec to 10min
- Detection Angle:** 170°
- Operating Temperature:** -10°C ~ +45°C
- Working Humidity:** 10% ~ 25%RH (No condensation)
- Installation:** 3M sticker or screws (included)
- Fixed bracket** (adjustable installation angle, 360°rotatable)

Read instructions carefully before installation

LUX ADJUSTMENT

The LUX adjustment determines at what light level the PIR sensor will start operating the lights when it senses movement. Simply set the LUX control knob from night time (30lux) to daylight (3500lux).

SENSITIVITY ADJUSTMENT

The sensitivity may be adjusted to compensate for seasonal variations in temperature and to reduce unwanted triggering.
For outdoor installation the optimum sensitivity can be achieved by setting the control knob to 70% (~7m), observing the "OUT" marking on the sensor.

For indoor installation adjust the control knob clockwise to increase the detecting distance (up to 10m) or anti-clockwise to decrease the detecting distance.

TIME ADJUSTMENT

The TIME adjustment controls how long the light will stay on after the last movement has been detected.
Turn the control knob clockwise to increase the delay time (up to about 10 minutes) or anti-clockwise to decrease the time delay (down to about 3 seconds).

Installation:

Screw Installation:
Use the provided screws to install the infrared sensor on a wall or on the ceiling, indoor or outdoor (Fig.1).

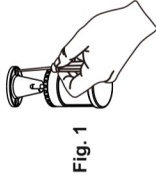

Fig. 1

Adhesive Installation:

Choose the installation position; clean the surface to ensure there is no oil/water etc.
Take the double sided adhesive tape (included) and tear the film on one side (Fig.2).
Paste the tape on the bottom of the PIR (Fig.3).



Fig. 2

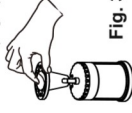
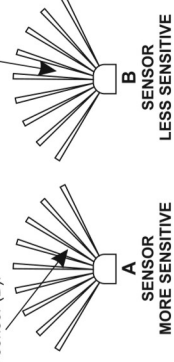

Fig. 3

Place the switch in the required position. The glue will be dry after 24 hours depending on conditions.

Choosing a Mounting Location:

- For the best results, fix your sensor on a solid surface, 1.8-2.5M above the ground.
- When choosing the mounting position consider that the sensor is more sensitive to motion across the detection field (A) and less sensitive to motion directly towards the sensor (B).



A
SENSOR
MORE SENSITIVE

B
SENSOR
LESS SENSITIVE

Outdoor Mounting Location:

- For outdoor installation the sensor strength is lower than indoors, so the sensitivity knob must be set to 70% observing the "OUT" marking on the sensor.
- For outdoor a location under eaves is preferable.
- Avoid aiming the motion sensor at pools, heating vents, air conditioners or objects that may change temperature rapidly.
- Do not allow sunlight to fall directly on the front of unit.
- Try to avoid pointing the unit at trees or shrubs or where the motion of pets may be detected.

Pairing Method:

Before pairing the PIR sensor, open the battery compartment and remove the plastic protection film from the battery to activate the PIR. (see how to open the compartment next page in "Battery Replacement")

Step 1: Press and hold the pairing button on the PIR sensor (Fig.4) for 3 seconds; the green LED sensor indicator will flash slowly (flashing once per second) and then release the button.

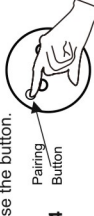

Fig. 4

Step 2: Press the pairing button on the controller (Fig.5) for 3 seconds, the controller indicator flashes slowly (flashing once every second), and then release the button. The controller enters the pairing mode.



Fig. 5

Step 3: Press the pairing button on the PIR sensor once; after the indicator on the controller stops flashing, the pairing is successful. This pairing method will control the light automatically by turning it on when a person is sensed, and the light will automatically be turned off if the person leaves the area.

Troubleshooting:

- If pairing does not work, first check if the indicator light is lit. Follow the pairing steps to re-pair the sensor.
- If the sensor does not respond check the following:
 - The battery transparent film has been removed.
 - The battery is not low level. If the red indicator light flashes, replace the battery.
 - Check the that distance from the sensor to the controller does not exceed the maximum controlling distance.
 - Ensure sensor is mounted correctly, facing the desired detection area.
 - Ensure the Lux level and Sensitivity are set up correctly.

Product dimensions:

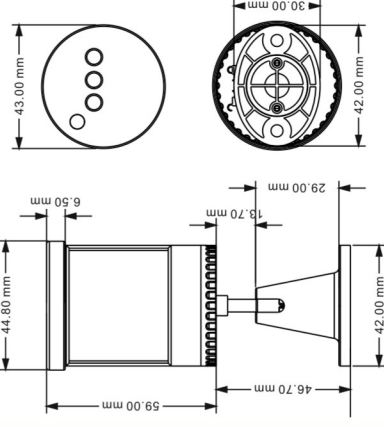

Replacing the Battery:

If the PIR remote control becomes insensitive after a period of time or the control distance becomes much shorter please replace the battery.
When the battery level is under 10% a Red LED indicator will flash quickly.

To replace the battery follow the steps below:

- Turn the PIR counter-clockwise to open the battery compartment (Fig.6).
- Replace the battery with a CR2450 Lithium battery.
- Close the battery compartment by turning the PIR clockwise.

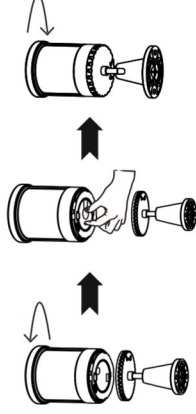

Fig.6 Replacing the battery